

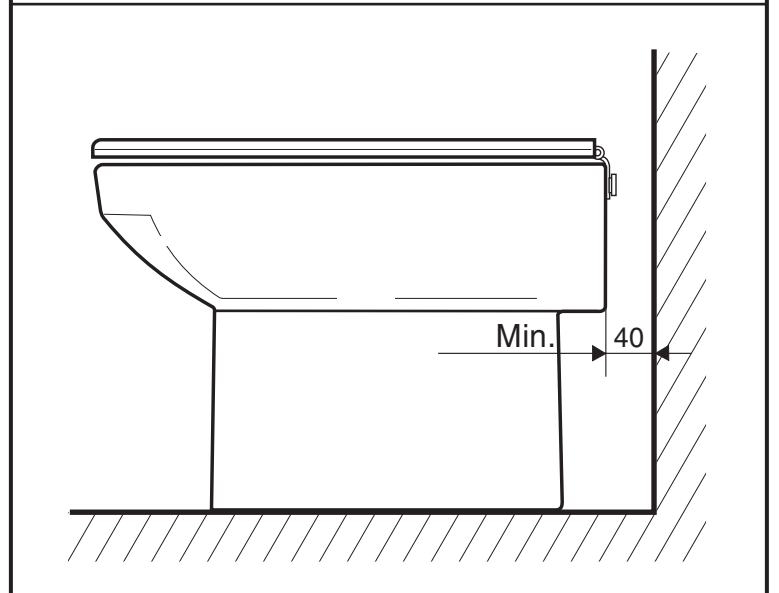

# Roca

## DAMA SENSO

8-06510

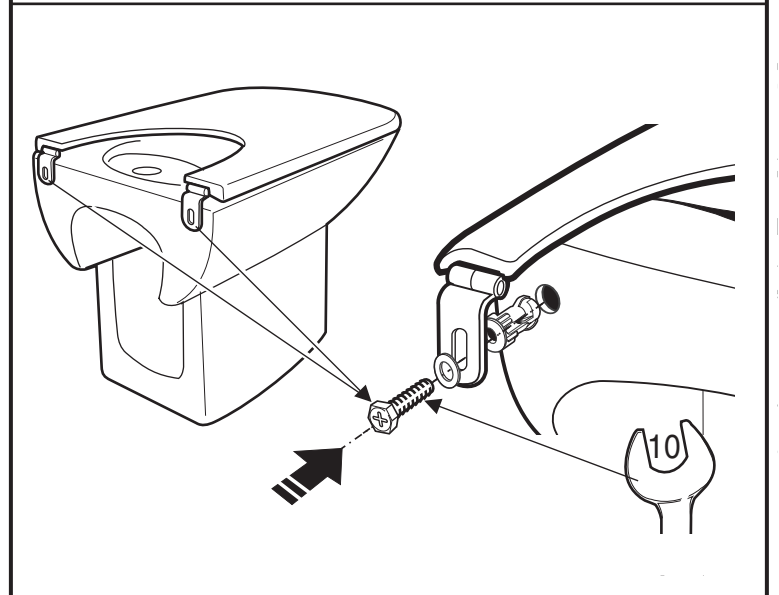
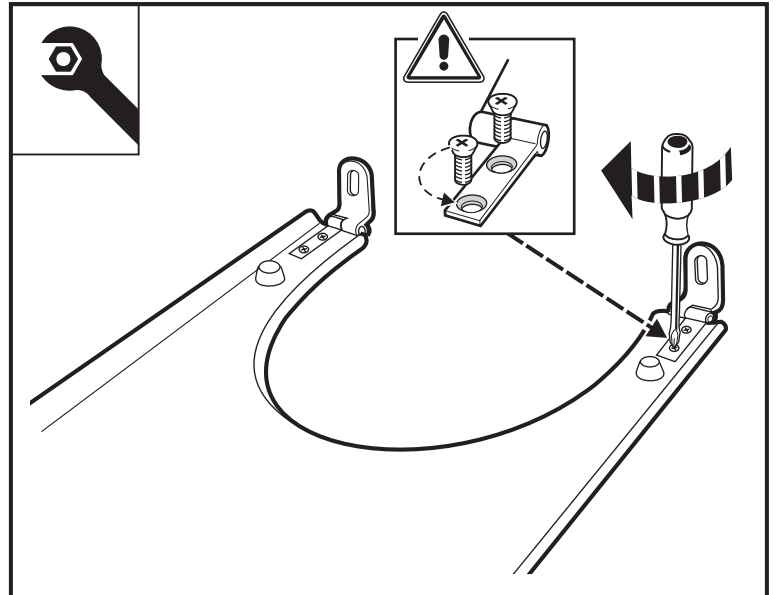

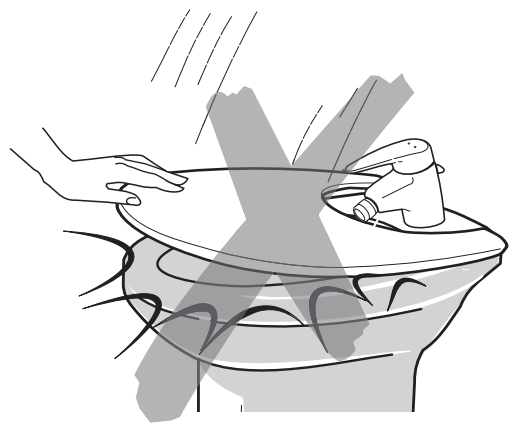

**Roca Sanitario, S.A.**

Avda. Diagonal, 513  
08029 Barcelona - SPAIN  
Teléfono 93 366 1200  
Fax 93 419 4501  
[www.roca.es](http://www.roca.es)

**Roca**